

AC-630 Diaphragm Meter



Designed to meter a variety of gases for large residential/commercial/small industrial applications at pressures up to 25 PSIG and flow rates to 630 SCFH at 1/2" W.C. differential pressure

Features

- Die-cast aluminum case
- Oil-impregnated, self-lubricating bushings
- Molded, convoluted diaphragms for smooth operation and long life
- Rigid, reinforced flag rods for positive alignment and sustained accuracy
- Graphite-filled phenolic valves to minimize wear
- Long-life, low friction, grommet seals
- Single coat polyester primer with high solids polyurethane top coat
- Security seals that indicate tampering

Advantages

- Temperature compensation available from -30°F to 140°F (-34°C to 60°C)
- 630 SCFH (17.8 m³/h) (0.60 specific gravity gas) at 1/2-inch W.C. differential
- AMI/AMR compatibility
- Meets ANSI B109.2 specifications
- Measurement Canada accredited

Applications

The AC-630 is ideally suited for larger residential, commercial and small industrial installations. It is unequalled for accuracy retention and for life cycle maintenance economies.

Options

- Regular or Temperature Compensated
- Pointer or odometer index
- 2ft³ or 0.05m³ drive
- 20 LT, 30 LT, 45 LT and other connection sizes
- 25 PSIG (1724 mBar) Maximum Allowable Operating Pressure (MAOP)
- Pressure compensating indexes
- Standard or UV protected index covers
- Meter bars
- Connection sets
- Remote Volume Pulsers
- 7" or 8.25" center-to-center connections



elster
American Meter

AC-630 Diaphragm Meter

Weight = 21 lbs

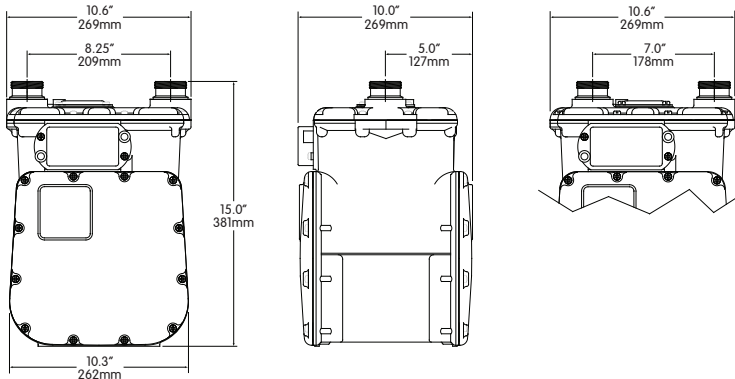

Capacities (0.60 specific gravity gas)

Line Pressure PSIG (mbar)	Differential Inches W.C. (mbar)	SCFH (m ³ /h)
0.25 (17)	1/2 (1.2)	630 ^{1,2} (17.8)
0.25 (17)	2 (5)	1320 (37.4)
1 (69)	2 (5)	1340 (37.9)
2 (138)	2 (5)	1390 (39.4)
5 (345)	2 (5)	1515 (42.9)
10 (690)	2 (5)	1710 (48.4)
15 (1035)	2 (5)	1890 (53.5)
20 (1380)	2 (5)	2010 (56.9)
25 (1724)	2 (5)	2160 (61.2)

1 - Propane - 397 cfh (11.2 m³/h)

2 - Butane - 347 cfh (9.8 m³/h)

AC-630 Proof Curve

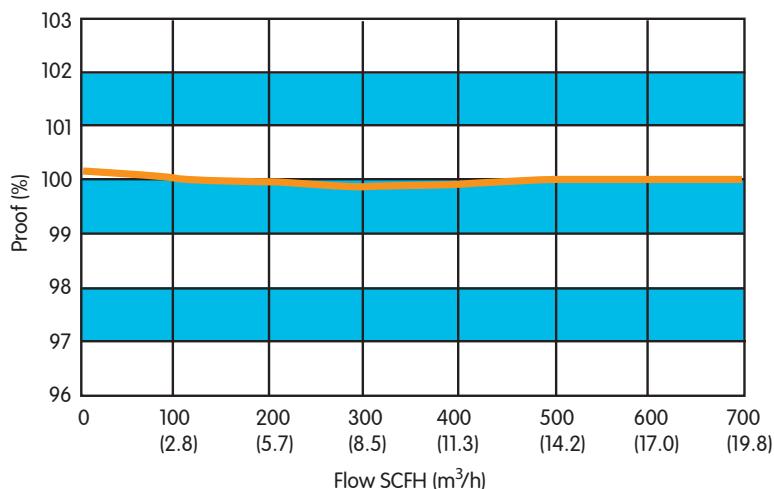

About Elster Group

A world leader in advanced metering infrastructure, integrated metering, and utilization solutions to the gas, electricity and water industries. Elster's metering and system solutions reflect over 170 years of knowledge and experience in measuring precious resources and energy.

Elster provides solutions and advanced technologies to help utilities more easily, efficiently and reliably obtain and use advanced metering intelligence to improve customer service, enhance operational efficiency, and increase revenues. Elster's AMI solutions enable utilities to cost-effectively generate, deliver, manage, and conserve the life-essential resources of gas, electricity, and water.

Elster has a staff of over 7,500 serving customers globally in North America, Central America, South America, Europe, Asia, Africa and the Middle East.

ISO 9001:2000



Certification No. 006697

Elster American Meter
2221 Industrial Road
Nebraska City, NE
68410
USA

T +1 402 873 8200
F +1 402 873 7616

www.elster-americanmeter.com

Elster Canadian Meter

T +1 519 650 1900
F +1 519 650 1917

www.elster-canandianmeter.com

© 2008 Elster American Meter. All right reserved

EAM-DS3550.7-EN-P - November 2008
Supersedes EAM-DS3550.6-EN-P